

IDENTIFICATION, MEASUREMENT & DEVELOPMENT OF DESIGN SKILLS IN ENGINEERING EDUCATION

Jami J. Shah

Keywords: Design Education, grading, empirical studies, measurement of skills

1 Introduction

Traditional engineering education focuses heavily on the development of analytical skills. Logical and convergent thinking are rewarded, both by the nature of the problems given and the way they are graded. Also, grades are computed from weighted sum of homeworks, exams, and other assignments. The only score that is recorded is the aggregate score for each assignment. This single score hides the strengths and weaknesses of an individual. Even if some of the exercises, or parts thereof, were designed to test skills relevant to design, such as idea generation, such record keeping does not keep track of how each student is doing in various aspects of the course. More importantly, the Instructor does not know directly how well the exercises, projects, etc. are related to the course objectives. This study enumerates and characterizes a set of design skills which could be used in developing design exercises and the basis for an alternative grading system.

2 Engineering Curriculum

The typical 4-year engineering curriculum consists roughly of about 1.5 years of math and basic sciences, followed by 1.5 years of engineering science subjects (thermodynamics, solid and fluid mechanics, controls, electromagnetics, etc.). Technical electives and design are typically late in the sequence with the exception of some lightweight coverage in some freshman engineering classes. The science based regimen promotes convergent thinking and deductive reasoning through closed ended problem solving. While these skills are extremely valuable to any engineer, they are insufficient for design. Design requires abductive reasoning, not only deductive; it requires divergent thinking, not only convergent thinking; it requires creative thinking, not only critical thinking. In this paper, we claim that the types of exercises and grading method induce a particular attitude and behavior. The habits formed in the early years of a science-centric curriculum are not compatible with design education.

Design educators need to become aware of how to “modify” student attitude and behaviors to make design learning more effective. Changes in course content, learning instruments (projects, exercises) and evaluation methods (grading) need to be synchronized. It seems that these must all be derived from the end objective – the range of skills we wish to develop in our students. Apart from specific domain knowledge, what skills define a good designer? It seems that an explicit enumeration of these skills and methods for observing and measuring them would contribute immensely for setting our educational goals. In fact, the US National Academy report on engineering design specifically mentions the need for developing metrics

for evaluating designs and metrics for the effectiveness of the design component of the curriculum [17].

In 21 years in academia, this author has observed many trends, some transient and some long lasting. Two current trends are worth mentioning. The first one is related to engineering education as a whole. In research intensive universities, engineers are gradually being replaced by mathematicians and applied scientists on faculties. This is because hiring decisions are driven by research funding trends. Fewer and fewer faculty have worked as engineers in industry. This is driving the curriculum further into teaching the scientific method rather than the engineering method¹. The consequence of this trend with respect to the subject of this paper is that design faculty must develop their own norms for exercises and grading to alter student behavior. The second trend is related specifically to engineering design. After several decades of teaching design from [22] type texts that focus narrowly on failure analysis and sizing of machine components, the pendulum appears to have swung completely to the opposite direction. There are now many “soft” courses in product development process that appear more appropriate for business schools – they lack substantive technical content. The challenge is how to teach both the science and the art of design in an integrated way within the time constraints of the 4-year BS degree program.

3 Design Skills

The central idea in this paper, a new method of grading, is based on the identification and measurement of design skills, which are derived from observations of design tasks. In this study we define a skill as the ability to perform a task. A good designer or design team must possess a wide range of skills to tackle all phases of product development, from problem definition to detailed design. Although these skills are indirectly alluded to in design textbooks and curricula, and every educator is well aware of them, there has not been an attempt to explicitly identify them, nor are there formal methods for measuring them.

At a broad, generic level, we can group design tasks into the following general areas:

- understanding what is required and formulating a plan of attack
- generating design concepts and evaluating their potential
- working out engineering details through modeling and simulation
- prototyping, testing and redesigning
- finalizing and documenting

In this paper, the treatment of skills is limited to individual designers; social aspects of design, such as group dynamics and collaboration, are not considered at the present time. This is not to say that social aspects are any less important, but simply to state of the focus of this effort. Few people will dispute the generic ingredients of design given in the above list, so we begin by analyzing the individual skills needed in performance of the design tasks encountered in each of the above phases.

3.1 Problem Formulation

No matter how simple or how complex the designed system or component, no matter if it is novel or routine design, any designer must first understand what the design requirements are. Various aids have been devised for this purpose, such as objective trees [4], check lists [18], QFD charts [2] and spec sheets. Proper problem formulation also helps in devising a good

¹ For a discussion of differences see Koen’s ASEE publication on the subject [12]

plan of attack and where to look for solutions (sources of information to seek, models/formulas to use, etc). The indicators of problem formulation skills are:

- asking probing questions to discover hidden requirements, constraints;
- ability to translate customer needs into technical specs;
- ability to distinguish between real and fictitious constraints;
- ability to decompose problems into manageable units;
- discovering what the real problem is – distinguishing between what is hard to achieve and what is routine; focusing on hard issues first

Protocol studies of experienced designers and novices have shown the differences in how they each approach problems [3,4,6]. While novices appear more systematic, giving equal attention to all requirements, experienced designers appear to quickly home in what the real challenge is, so they spend most of their energies on those issues, leaving routine aspects to later, after the difficult issues have been resolved.

Using the attributes given above for *problem formulation skill (PD)*, one can design exercises and evaluate objectively an individual's proficiency in problem formulation.

3.2 Concept Generation & evaluation

For conceptual design, we have identified four distinct skills: Lateral Thinking, Imaginative Thinking, Visual Thinking, and Qualitative Reasoning (Abstract Vertical Thinking).

Lateral Thinking (LT)

The opportunity for innovative designs varies with the type of design problem, but divergent or *lateral thinking (LT)* is the relevant skill. At the conceptual phase in design, we would like to encourage that students spend time generating many alternatives, i.e., explore the design space well. Using only the number of ideas generated as a measure of LT, as this author did in early days of developing this system, proved to be inadequate. Students simply would generate superficial variations of the same basic design. Therefore, a measure of variety is needed to determine how well the design space has been explored. Thus, we define the number and variety of ideas generated as indicators of Lateral Thinking.

From a cognitive science point of view, variety in idea generation is a measure of the number of categories of ideas that one can imagine [21]. The measure of variety is an indication of the multiple perspectives that one may use in solving a problem. Often, one finds that routine approaches to problems can lead to uncreative ideas. In such cases, the original cognitive knowledge structures applied to a problem are inappropriate, and insight can be achieved only through what cognitive psychologists have called *cognitive restructuring* [7]. The ability to generate a wide variety of ideas is directly related to the ability to restructure problems, and is therefore an important measure of creativity in design.

The conceptual origins of ideas are analyzed through a genealogical categorization (Figure 1) based on how ideas fulfill each design function. At the highest level, ideas are differentiated by the different physical principles used by each to satisfy the same function; this is the most significant extent of finding differences between ideas. At the second level ideas are differentiated based on different working principles but they share the same physical principle. At the third and fourth levels, ideas have different embodiment and different detail, respectively. The nodes in the tree carry the count of ideas in each category at each level.

The number of branches in the tree gives an indication of the variety of ideas. If greater variety is to be valued, branches at upper levels (physical principle differences) should get

higher rating than the number of branches at lower levels. For example, values of 10, 6, 3, and 1 to physical principle, working principle, embodiment, and detail levels respectively can be used. These values would ensure that separation at higher levels will always score a greater total. If there is only one branch at a given level, it shows no variety and the score should be zero; otherwise the score should be the number of branches times the value assigned to that level. The genealogy tree needs to be constructed for each of the functions of a device. Not all the functions are equally important, so one can assign weights to account for the importance of each. One method for quantifying variety based on genealogy is described in detail in [21]. Of course, one does not need to conduct this analysis at these four levels for all designs; a subset of these may suffice. For example, if the ideas do not contain enough detail to go as far as the lowest level, and if it is hard to distinguish between physical and working principles, one could use just the working principles and embodiment levels.

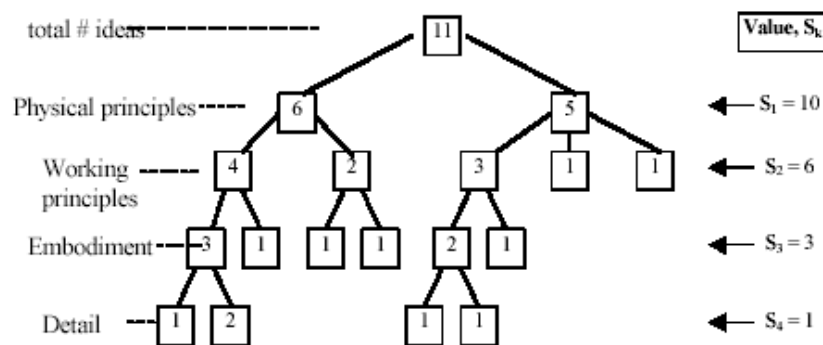

Figure 1. Genealogy tree for evaluating variety [21]

Imaginative Thinking (IT)

While quantity and variety of concepts measure divergent or lateral thinking, i.e., the skill to explore design space, there is another element that needs to be considered: the ability to expand the design space (thinking outside the box). It is this skill that may lead to unusual or novel designs. For lack of a better term, we label this as *Imaginative Thinking (IT)*. The ability to measure this depends on indicators of novelty.

The use of a measure of novelty in idea generation is of fundamental importance. In terms of design space, novel designs occupy points that are initially not perceived to be within the design space. Expanding the design space offers the opportunity to find better designs that have so far not known to exist. Many idea generation methods provide deliberate mechanisms to view the problem in a different way, to use analogies and metaphors, to play around by loosening the tight grip on goals that engineers generally have. Novelty can be assessed at multiple levels, depending upon the scale [21].

Two approaches may be taken to measure novelty. The universe of ideas for comparison can be obtained by defining what is not novel (what is usual or expected), preferably before analyzing any data to avoid biasing. Alternatively, we can collect all ideas generated by all participants from all methods, identify key attributes such as motion type, control mechanism, propulsion, etc. Then find all the different ways in which each of those attributes is satisfied (example: motion = rotating, sliding, oscillating, etc.). Then we can count how many instances of each solution method exist in the entire collection of ideas. The lower the count (i.e., the less a characteristic is found) the higher the novelty.

The problem is first decomposed into its key functions or characteristics. Every idea produced is analyzed by first identifying which functions it satisfies and describing how it fulfils these

functions, at the conceptual and/or embodiment level. Each description is then graded for novelty according to one of two approaches. It is possible to compute a total score for novelty for each idea, by applying the weights to each function and stage. The calculation of the novelty score for each function depends on the approach chosen. For the first approach (a priori knowledge) a universe of ideas for comparison is subjectively defined for each function or attribute, and at each stage. A novelty score S_1 is assigned at each idea in this universe. To evaluate the function and stage of an idea a closest match is found in the table and the score noted. For the second approach, it is calculated from $S = (T-C)/T$, where T is the total number of ideas produced for function (or key attribute) and C is the count of the current solution for that function (or key attribute) and stage. This metric has also been used by psychologists to measure creativity [24,25, 11].

Visual Thinking (VT)

Visual thinking involves the interaction between mental (imagining), graphical (drawing), and perceptual (seeing) images [14]. Tovey [26] describes several case-studies (Citroen 2CV, Jaguar XJS) to emphasize the importance of *visual thinking* and *drawings* in the design process. The role of visual thinking in creativity has been studied extensively. Henderson [10] asserts that sketching is essential when trying to convey ideas and information. Thus, sketching is a predominant activity by the designer [13]. During the design process sketching accounts for 67% of all that was drawn over the course of design [27]. In architectural design, Goldschmidt [9] studied how “serial sketching” progresses, and how unexpected relationships and new shapes emerged outside the scope intended. This indicates that sketches provide a feedback (talk-back) to the sketcher. Through the cycle of sketching, inspection, and revising, the designer is in a sense having a conversation [23], but this conversation is greatly affected by one’s ability to use imagery. According to Verstijnen, [28], creative discovery is the result of a set of mental operations on a visual image. Sketches help in capturing fleeting images and may provide additional connections and visual insight [8,13,14,23,19]. Sketching is the medium for improving the evaluation and restatement of design problems [13]. Since pattern seeking occurs naturally in visual thought, connections are more spontaneously made in the designers mind. A gestalt phenomenon occurs when the designer reviews a sketch and is able to extract information beyond what was originally intended. Ambiguity in a sketch may spark ‘unexpected connections’, which is a promoter of creativity in design. Freehand sketches, characterized by ambiguity and informational denseness, contribute positively toward creative and explorative aspects of problem solving. Design is, therefore, purported to be a reflective, responsive and opportunistic process whereby designers construct their own reality through a unique design situation [23]. An empirical study tested and confirmed the hypothesis that graphical (pictorial) representation leads to higher variety and novelty than textual (sentential) [15].

The indicators of Visual Thinking for evaluating design skills are the number and quality of sketches/graphics used in reasoning/concept generation, the level of engineering drawing skill.

Qualitative Reasoning/Abstract Vertical Thinking (AVT)

Although not studied as extensively as Visual Thinking, AVT is a key skill in engineering design [5] and one that apparently not picked up in engineering science classes. In these classes, students work with precise definitions and complete information. Examples of problems used in engineering science classes are:

- A given body is launched along a vector V at velocity X , determine where it will land.
- Where is the maximum Von Mises stress in a given structure under the given loads.

The habit that is formed by these types of problems is to find the right set of formulas and to plug in the known variables to successively find the unknowns. Because design problems are not in this form, students have considerable difficulty applying analytical methods at the conceptual stage (too many unknowns to be able to use the formulas). What is needed is the ability to abstract mathematical formulas into qualitative relations. For example, making an observation like, “if I increase the surface to volume ratio, I can reduce the internal temperature”, or “there is conflict between the objective of capturing the most solar energy and retaining it: one requires area increase, the other decrease the surface area”.

The indicators of AVT are the ability to make good assumptions, simplify formulas, work with incomplete or fuzzy data, and make strategic observations about qualitative relationships and conflicting requirements.

3.3 Engineering Analyses and Simulation

This paper will say very little about engineering analysis because it is generally well covered in our curriculums. However, in addition to a strong background in analytical methods and domain-specific tools, one needs empirical knowledge, as well. At the detailed stage of design, we conduct parametric studies to determine the best parameter values to meet our objectives. Heuristic or numerical optimization may be conducted, or simply a feasible design chosen, if that is the design goal. Therefore, the skill important at this stage is convergent think, which we label here as *Quantitative Vertical Thinking (QVT)*. It can be evaluated by determining the thoroughness and accuracy of the analyses, appropriate for the domain.

Another skill that permeates the entire design process is decision making. It takes on different forms in conceptual and detailed design. In conceptual design, decision typically involves selecting the design alternatives that show the greatest potential for further development. In detailed design, due to lack of time and budget constraints, it is not uncommon to be working with a single design concept and developing it further. Many decisions need to be made at every stage, such as material selection, geometric shapes, sizes, etc. There is usually enough information available to make these decisions on the basis of quantitative analysis. Decisions must be related to design objectives. The proper formulation of the decisions (derived from objectives) and knowledge, selection and application of decision methods and procedures are indicators of *Decision Making* skill (DM). This author has seen considerable mis-use of decision tables with arbitrarily assigned weights and probabilities.

3.4 Other Skills

Although not essential for every designer, knowledge of experimental methods for building and testing could also be evaluated. Certainly the awareness of manufacturability issues is an asset to the designer. Evaluation of *fabrication (FAB)* skill can only be done from projects involving construction of designs or prototypes; design contests are a good medium for this.

Finally, the detailed design and its rationale need to be documented properly in order to communicate the design to other departments or to manufacturing. The quality of project reports, describing the design process, issues, alternatives, rationale, and description of the artifact, can be used as indicators of Technical Communications (COM).

We reiterate that our skills enumeration does not include skills needed for working in collaborative groups. That subject is left for another day.

4 Grading Methods

All teachers are aware that most students create strategic plans to maximize their grade with minimal effort, i.e. each student will optimize his/her own “utility” according to their objectives and constraints. At the beginning of the semester, they want to know how the course grade will be computed, what weights will be assigned to homeworks, labs, exams, etc. Before exams, it is not uncommon to get questions that probe the “probability” of certain topics or types of questions that will be on the exam. Presumably the motivation for these questions is for the student to set priorities in preparing for an exam. Engineering students are very bright - they will maximize their rewards to effort ratio based on the rewards system. To induce the desired behavior, the instructor must reward what he/she considers important for a given course, or “put your money (grade) where your mouth is”. To encourage out of the box thinking, we must reward risk-taking, unconventional and unusual ideas. Factors that influence student attitude include course format, content, problem types used in homeworks, labs, projects, exams, and the evaluation/grading system. We begin by examining the conventional grading system and then the evolution towards a new system.

4.1 Conventional Method

We will label the conventional system as “assignments centric” for reasons that are obvious from Figure 2. The grades are computed from weighted sum of homeworks, exams, and other assignments. The only score that is recorded is the aggregate score for each assignment. This single score hides the strengths and weaknesses of an individual. Often, logical and convergent thinking are rewarded, at least indirectly, both by the nature of the problems given and the way they are graded. Even if the exercises were designed specifically to teach/evaluate certain design skills, recording a single score is not adequate. The advantages of the assignment based conventional method is that it is easy to execute, the students are familiar with it since it is similar to methods used in all types of classes, and they know where they stand, by looking at averages and ranking.

weights								0.1	0.15	0.1	
ASU ID	STUDENT NAME	HW#1	HW#2	HW#3	HW#4	HW#5	HW#6	Total HW	EXAM#1	PROJ 1	%AGE
MAX POINT		65	60	30	50	10	30	100	100	100	100
8-5411	MINO	56	60	26	42	10	27	90.20	97	96.4	94.9
0-1406	LAI	63	58	30	46	10	28	95.92	94	91.2	93.7
2-8839	ELI	62	59	23	42	10	28	91.43	84	102	91.3
0-3023	LE	59	58.5	30	43	10	26	92.45	84	90.1	88.2
2-2487	FR	58	56	23	38	10	0	75.51	77	98.4	82.7
4-2127	GC	63	59	25	48	10	28	95.10	70	89.3	82.7
3-0964	CF	60	57	30	45	10	26	93.06	76	81.6	82.5
9-3759	ML	54	58	25	50	9.5	30	92.45	93	54	81.7
9-3960	ML	53	58.5	26	50	9.5	30	92.65	84	67	81.6
8-9239	JA	61	58.5	30	34	9	26	89.18	68.5	92.2	81.2
7-1700	GC	64	58	30	47	10	26	95.92	77	70.4	80.5
1-8602	BE	47.5	59	27	40	9.5	27	85.71	84	70	80.5
4-8652	GA	49	56	22	38	9.5	23	80.61	71.5	93.5	80.4
9-8398	DJ	61	58	30	43	10	26	93.06	68	81.4	79.0
9-7223	VEI	63	59	30	42	10	27	94.29	50	105	78.4
4-7034	BUJ	57	59.5	30	39	9.5	28	91.02	57	97.6	78.3
0-6376	VOF	55	54	21	34	10	24	80.82	71.5	86	78.3
5-4369	HUC	58	55	35	0	9	24	73.88	67	96.4	77.4
0-2238	RIM	62	54.5	22	39	10	28	87.96	80	62	77.1
6-3741	SMI	62	57	24	47	9	27	92.24	66	70	74.6
0-3655	WIL	58.5	55	25	27	9	0	71.22	74	73.8	73.1
CLASS HIGHEST		64	60	35	50	10	30	95.92	97	105	94.9
CLASS AVE		55.47	53.47	22.29	30.42	9.197	20.24	82.28	66.128	69.74	70

Figure 2. An assignment based grade book

4.2 Evolution of grading method

In the quest to track the strengths and weaknesses of students in design courses as measured initially in informal ways, the author did away with numerical scores all together. These were replaced by writing remarks about each student, on each exercise, and then creating a summary at the end of the semester (Figure 3). Since the University's Registrar Office did not have any mechanism to embed these remarks into student transcripts, the instructor was forced to provide a letter grade (A to E). This method proved to be tremendously unpopular with the students. Not only was this grading method a radical departure from the standard method, they claimed that without numerical averages and rankings they had no idea where they stood in the class. This was surprising to the instructor because he thought the students had more specific information now about their strengths and weaknesses. After two semesters of experimenting with this method, it was abandoned in favor of the method described next.

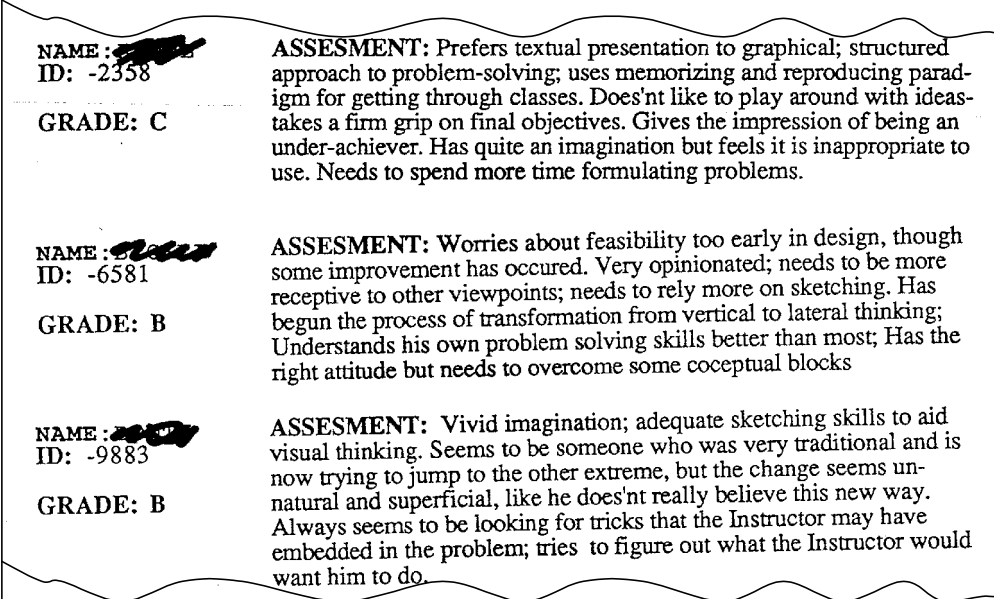

NAME : [REDACTED] ID: -2358 GRADE: C	ASSESSMENT: Prefers textual presentation to graphical; structured approach to problem-solving; uses memorizing and reproducing paradigm for getting through classes. Does'nt like to play around with ideas-takes a firm grip on final objectives. Gives the impression of being an under-achiever. Has quite an imagination but feels it is inappropriate to use. Needs to spend more time formulating problems.
NAME : [REDACTED] ID: -6581 GRADE: B	ASSESSMENT: Worries about feasibility too early in design, though some improvement has occurred. Very opinionated; needs to be more receptive to other viewpoints; needs to rely more on sketching. Has begun the process of transformation from vertical to lateral thinking; Understands his own problem solving skills better than most; Has the right attitude but needs to overcome some coceptual blocks
NAME : [REDACTED] ID: -9883 GRADE: B	ASSESSMENT: Vivid imagination; adequate sketching skills to aid visual thinking. Seems to be someone who was very traditional and is now trying to jump to the other extreme, but the change seems unnatural and superficial, like he does'nt really believe this new way. Always seems to be looking for tricks that the Instructor may have embedded in the problem; tries to figure out what the Instructor would want him to do.

Figure 3. Summary remarks replacing numerical scores

4.3 Skill based Method

The solution to difficulties outlined in the last section, without abandoning the desire to keep explicit record of strengths and weaknesses seemed obvious: explicate and quantify. There are three main elements involved in the new skill based learning and grading system:

- explication of design skills
- association of skills sub-sets for each design exercise
- record keeping and aggregation of scores organized by skills

At the start of the semester, students are briefed on what skills are important in design. The indicators of each skill and the method of measurement are discussed. This would be similar to what is presented in Section 3 of this paper.

Each class exercise or assignment must be designed with the objective of teaching, practicing, assessing a particular sub-set of skills. Students are told in advance the particular skill(s) that are to be graded on each exercise. The specified skills are assessed in light of each exercise and the result is quantified (Figure 4). Grade books can then record a running total of the score on each skill computed from the assignments. That is to say that scores for each skill are *separately* aggregated in order to not lose sight of how a student is performing in each one.

Since the first introduction of the skill based method, we have continued to tweak the list of skills and refine their definition and indicators (Figure 5). For some skills (LT, IT) objective measures have been developed while others are still subjective. The critical element is the creation of design exercises that are focused on specific skills. Some examples are given in the Appendix.

SS#	Creativity	Lateral Thinking	Imagination	Drawing Ability	Visual Thinking	Problem Definition	VT/ Analysis	GRADE	Comments
-9098	1 2 3 4 5	1 2 3 4 5	1 2 3 4 5	1 2 3 4 5	1 2 3 4 5	1 2 3 4 5	1 2 3 4 5	A B C D E	Systematic
-9239	1 2 3 4 5	1 2 3 4 5	1 2 3 4 5	1 2 3 4 5	1 2 3 4 5	1 2 3 4 5	1 2 3 4 5	A B C D E	Traditional and safe
-0287	1 2 3 4 5	1 2 3 4 5	2 3 4 5	1 2 3 4 5	1 2 3 4 5	1 2 3 4 5	1 2 3 4 5	A B C D E	Lack of effort
-7486	1 2 3 4 5	1 2 3 4 5	1 2 3 4 5	1 2 3 4 5	1 2 3 4 5	1 2 3 4 5	1 2 3 4 5	A B C D E	Follows recipes
-4309	1 2 3 4 5	1 2 3 4 5	1 2 3 4 5	1 2 3 4 5	1 2 3 4 5	1 2 3 4 5	1 2 3 4 5	A B C D E	Much improved, especially drawing
-4830	1 2 3 4 5	1 2 3 4 5	1 2 3 4 5	1 2 3 4 5	1 2 3 4 5	1 2 3 4 5	1 2 3 4 5	A B C D E	Well balanced, left/right
-8514	1 2 3 4 5	1 2 3 4 5	1 2 3 4 5	1 2 3 4 5	1 2 3 4 5	1 2 3 4 5	1 2 3 4 5	A B C D E	Needs to believe!
-1022	1 2 3 4 5	1 2 3 4 5	1 2 3 4 5	1 2 3 4 5	1 2 3 4 5	1 2 3 4 5	1 2 3 4 5	A B C D E	Poor overall, did minimum
-9425	1 2 3 4 5	1 2 3 4 5	1 2 3 4 5	1 2 3 4 5	1 2 3 4 5	1 2 3 4 5	1 2 3 4 5	A B C D E	Began to apply techniques
-9778	1 2 3 4 5	1 2 3 4 5	1 2 3 4 5	1 2 3 4 5	1 2 3 4 5	1 2 3 4 5	1 2 3 4 5	A B C D E	Logical and structured
-9008	1 2 3 4 5	1 2 3 4 5	1 2 3 4 5	1 2 3 4 5	1 2 3 4 5	1 2 3 4 5	1 2 3 4 5	A B C D E	Vertical thinker
-5166	1 2 3 4 5	1 2 3 4 5	1 2 3 4 5	1 2 3 4 5	1 2 3 4 5	1 2 3 4 5	1 2 3 4 5	A B C D E	Needs to spice it up!
-3932	1 2 3 4 5	1 2 3 4 5	1 2 3 4 5	1 2 3 4 5	1 2 3 4 5	1 2 3 4 5	1 2 3 4 5	A B C D E	Difficulty seeing big picture
-3295	1 2 3 4 5	1 2 3 4 5	1 2 3 4 5	1 2 3 4 5	1 2 3 4 5	1 2 3 4 5	1 2 3 4 5	A B C D E	Over anxious, fear of failure
-0118	1 2 3 4 5	1 2 3 4 5	1 2 3 4 5	1 2 3 4 5	1 2 3 4 5	1 2 3 4 5	1 2 3 4 5	A B C D E	Needs imagination
-5354	1 2 3 4 5	1 2 3 4 5	1 2 3 4 5	1 2 3 4 5	1 2 3 4 5	1 2 3 4 5	1 2 3 4 5	A B C D E	Could do better
-7797	1 2 3 4 5	1 2 3 4 5	1 2 3 4 5	1 2 3 4 5	1 2 3 4 5	1 2 3 4 5	1 2 3 4 5	A B C D E	Very creative, ex last project
-2024	1 2 3 4 5	1 2 3 4 5	1 2 3 4 5	1 2 3 4 5	1 2 3 4 5	1 2 3 4 5	1 2 3 4 5	A B C D E	Room for improvement
-7248	1 2 3 4 5	1 2 3 4 5	1 2 3 4 5	1 2 3 4 5	1 2 3 4 5	1 2 3 4 5	1 2 3 4 5	A B C D E	Lack of effort
-3986	1 2 3 4 5	1 2 3 4 5	1 2 3 4 5	1 2 3 4 5	1 2 3 4 5	1 2 3 4 5	1 2 3 4 5	A B C D E	No data
-7406	1 2 3 4 5	1 2 3 4 5	1 2 3 4 5	1 2 3 4 5	1 2 3 4 5	1 2 3 4 5	1 2 3 4 5	A B C D E	Methodically played the game
-1704	1 2 3 4 5	1 2 3 4 5	1 2 3 4 5	1 2 3 4 5	1 2 3 4 5	1 2 3 4 5	1 2 3 4 5	A B C D E	Lack of effort
-7179	1 2 3 4 5	1 2 3 4 5	1 2 3 4 5	1 2 3 4 5	1 2 3 4 5	1 2 3 4 5	1 2 3 4 5	A B C D E	Trouble seeing big picture
-7333	1 2 3 4 5	1 2 3 4 5	1 2 3 4 5	1 2 3 4 5	1 2 3 4 5	1 2 3 4 5	1 2 3 4 5	A B C D E	Be adventurous
-4313	1 2 3 4 5	1 2 3 4 5	1 2 3 4 5	1 2 3 4 5	1 2 3 4 5	1 2 3 4 5	1 2 3 4 5	A B C D E	Look for the non-obvious, use of
-9648	1 2 3 4 5	1 2 3 4 5	1 2 3 4 5	1 2 3 4 5	1 2 3 4 5	1 2 3 4 5	1 2 3 4 5	A B C D E	Has difficulty abstracting
-71320	1 2 3 4 5	1 2 3 4 5	1 2 3 4 5	1 2 3 4 5	1 2 3 4 5	1 2 3 4 5	1 2 3 4 5	A B C D E	Balanced LT & VT
-5471	1 2 3 4 5	1 2 3 4 5	1 2 3 4 5	1 2 3 4 5	1 2 3 4 5	1 2 3 4 5	1 2 3 4 5	A B C D E	Improve analytical skills
-6398	1 2 3 4 5	1 2 3 4 5	1 2 3 4 5	1 2 3 4 5	1 2 3 4 5	1 2 3 4 5	1 2 3 4 5	A B C D E	Weak in technical areas
-6837	1 2 3 4 5	1 2 3 4 5	1 2 3 4 5	1 2 3 4 5	1 2 3 4 5	1 2 3 4 5	1 2 3 4 5	A B C D E	Poor at quantitative work
-2833	1 2 3 4 5	1 2 3 4 5	1 2 3 4 5	1 2 3 4 5	1 2 3 4 5	1 2 3 4 5	1 2 3 4 5	A B C D E	Lack of effort
-1261	1 2 3 4 5	1 2 3 4 5	1 2 3 4 5	1 2 3 4 5	1 2 3 4 5	1 2 3 4 5	1 2 3 4 5	A B C D E	Minimal effort

Figure 4. An early attempt at skill based grading

ASU ID	LT	VT	AVT	QVT	PD	IT	FAB	DM	COM	%AGE	Grade
MAX POINT	65	60	30	50	10	30	65	100	100	100	
xxxxxx	62	59	23	42	10	28	59	84	102	92.0	A
xxxxxx	63	58	30	46	10	28	59	94	91.2	94.0	A
xxxxxx	56	60	26	42	10	27	57	97	96.4	92.4	A-
xxxxxx	54	58	25	50	9.5	30	56	93	54	84.2	B
xxxxxx	58	56	23	38	10	0	57	77	98.4	81.8	B
xxxxxx	53	58.5	26	50	9.5	30	56	84	67	85.1	B
xxxxxx	64	58	30	47	10	26	62	77	70.4	87.1	B
xxxxxx	59	58.5	30	43	10	26	57	84	90.1	89.7	B
xxxxxx	62	57	24	47	9	27	57	66	70	82.2	B
xxxxxx	58	55	35	0	9	24	56	67	96.4	78.5	B
xxxxxx	60	57	30	45	10	26	59	76	81.6	87.2	B
xxxxxx	57	59.5	30	39	9.5	28	61	57	97.6	86.0	B-
xxxxxx	61	58	30	43	10	26	48	68	81.4	83.4	B-
xxxxxx	59.5	52	23	35	10	0	58	63	84	75.4	B-
xxxxxx	61	56.5	23	45	10	27	50	54	84	80.5	B-
xxxxxx	60	56	25	35	9	0	55	64	63	72.0	B-
xxxxxx	63	59	30	42	10	27	56	50	105	86.7	C
xxxxxx	62	54.5	22	39	10	28	57	80	62	81.3	C
xxxxxx	55		21	34	10	24	0	71	96	69.7	C
xxxxxx			17	0	9	26	5			71.0	C
xxxxxx				48	10	2					C
					10						

Figure 5. The new grade sheet: summary page

When enough data on each student has been collected, we can visualize the students' strengths and weaknesses using a graphical representation that we term the "Designer Profile". It can show the skill level (normalized score) of each student with respect to the peer

group max/min, and/or means or norms (yet to be established). The Designer Profile clearly identifies a student’s strengths and weaknesses both to the student and the Instructor. The Designer Profile for a student is shown in Figure 6. This appears to be a Designer Profile for an individual who is very good at idea generation (LT+IT+VST) but mediocre at quantitative skills used in embodiment design (AVT+QVT+DM). The aggregated results for the entire class can also be graphically represented in a similar way – called “Class Profile”, shown in Figure 7. Class profiles may be useful in setting norms, tracking student or class progress, trends over many years, the influence of curriculum content and format, etc.



Figure 6. Designer Profile for student X

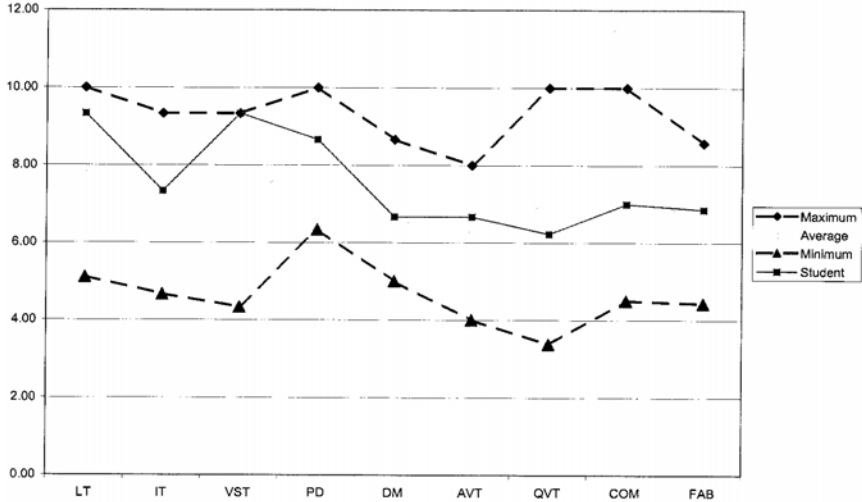

Figure 7. Class Profile for a junior design class

5 Validation

Some limited validation of the relevance of the skill based measures to design has been done, but this is just a beginning. So far two types of correlation studies were done. One was the correlation between ideation related scores (LT, IT) to ranking in design contests. This is shown in Figure 8. The project rank is the average finishing position in design contests. These were actual design-build-compete projects, examples of which are in the Appendix. The rank of a student depends on how the design performed: for example, did his device travel the farthest or collected the most balls, etc. It is not based on the design process followed, only the outcome. The LT score is the aggregate of all grades collected from all exercises during the semester. The horizontal axis is for student 1-37: for each student the red point shows that student’s average rank in all design contests combined and the corresponding blue point shows the average grade related to ideation. The scores have been normalized but the LT and

Project ranks are obviously on different scales, different units. What one needs to see is if a high LT score corresponds to a high average rank in contests. The statistical correlation factor is fairly high, which is encouraging. The other study was for relating the analytical skills (AVT, QVT) to scores on written formal exams. The results are shown in Figure 9; the correlation is somewhat moderate, but not as impressive as the results of the first study.

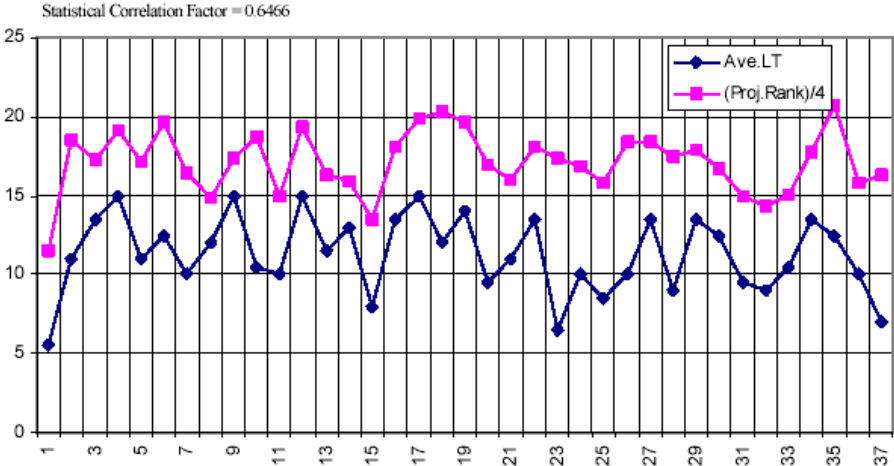

Figure 8. Correlation of ideation skill scores with performance in design contests

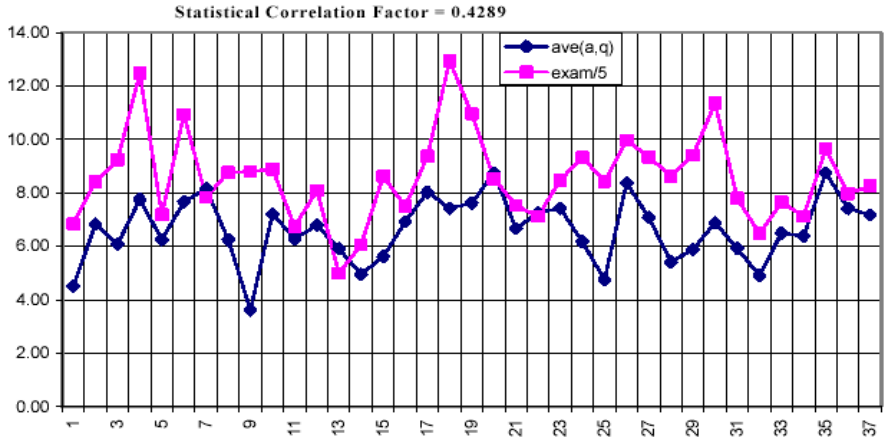

Figure 9. Correlation of analytical skill scores with performance in traditional exams

6 Conclusions

Designer Profiles provide relative evaluation; they only show where an individual is with respect to the class. Even if data from several semesters for the same class is added together, we still do not know what acceptable or target values to establish. Nevertheless, this relative evaluation in the form of Designer Profiles is useful in (1) Determination of design strengths/weaknesses of individuals for the purpose of corrective action; (2) Matching individuals with complementary strengths on design teams; (3) Continuous improvement and evaluation of course content.

At this stage, we are interested in getting feedback on this framework for evaluating design skills. If and when consensus on these skills and their measurement is reached, we will need to work with the design education community to establish benchmarks/norms for students at various levels, and perhaps even for engineers.

Acknowledgment

Partial support for this project came from US NSF Grant DMI-0115447. Opinions expressed are those of the author and not endorsed by NSF.

References

- [1] ABET, "Criteria accrediting engineering programs-effective for evaluations during 2003-2004 cycle", Nov. 2, 2002, Acc. Board for Eng. & Tech, Baltimore.
- [2] ASI, "The Four Phases of Quality Function Deployment", American Supplier Inst, 1989.
- [3] Christiaans H., and Dorst K., "An empirical study into design thinking", in Research in Design Thinking, Delft Press, 1991.
- [4] Cross N., Dorst K., and Roozeburg N., "Research in Design Thinking", Proc. of Workshop, Delft Univ. Press, 1991.
- [5] ED2030, "Strategic Plan for Engineering Design", NSF Workshop report, 2004.
- [6] Ericsson, K., Simon, H., "Protocol Analysis - verbal reports as data", MIT Press, 1984.
- [7] Finke R A, Ward T B and Smith S M Creative Cognition: Theory, Research, and Applications MIT Press, Cambridge MA , 1992.
- [8] Goel, V., 1995, Sketches of Thought, MIT Press, Cambridge, MA.
- [9] Goldschmidt, G., 1992, "Serial Sketching: Visual Problem Solving in Designing", Cybernetics and Systems, Vol. 23, No. 2, pp. 191-219.
- [10] Henderson, K., On Line and on Paper: Visual Representations, Visual Culture, and Computer Graphics in Design Engineering, MIT Press, Cambridge, MA, 1999.
- [11] Jansson, D. G., and Smith, S. M., "Design Fixation", Design Studies, Vol. 12, 1991.
- [12] Koen, B, "Definition of the Engineering Method", ASEE, Washington DC, 1985.
- [13] McGown, A., Green, G., Rodgers, P., "Visible Ideas: Information Patterns of Conceptual Sketch Activity", Design Studies, vol. 19, no. 4, 1998, pp. 431-53.
- [14] McKim, R., Experiences in Visual Thinking, Wadsworth, Inc., Belmont, CA, 1980.
- [15] McKoy, F., Vargas-Hernandez, N., Summers, J., Shah, J., "Influence of design representation on effectiveness of idea generation", ASME Design Theory & Methodology conf., Pittsburgh, PA, September 10-13, 2001.
- [16] McKoy, F., "Experimental Evaluation of Engineering Design Representations for Idea Generation", MS Thesis, Arizona State University, Tempe, AZ, 2000.
- [17] National Research Council (U. S.), "Improving Engineering Design: Designing for Competitive Advantage", National Academy Press, Washington, D. C, 1991.
- [18] Pahl & Beitz, "Engineering Design", Springer, 1995.
- [19] Purcell, A., Gero, J., "Drawings and the Design Process", Design Studies, V19(4), 1998.
- [20] Shah, J., Kulkarni, S., Vargas-Hernandez, N., "Evaluating the effectiveness of idea generation techniques in design: Metrics and Experimental Methodology", ASME Transactions, J. of Mechanical Design, V122 (4), 2000, pp 377-384.
- [21] Shah, J. J., Smith, S. M., Vargas-Hernandez, N., "Metrics for Measuring Ideation Effectiveness", Design Studies, vol. 24, no. 2, 2003, pp. 111-134.

- [22] Shigley, J., Mischke, C., Mechanical Engineering Design, 5th ed., McGraw-Hill, 1989.
- [23] Suwa, M., Tversky, B., “What Do Architects and Students Perceive in their Design Sketches? A Protocol Analysis”, Design Studies, vol. 18, no. 4, 1997, pp. 385-403.
- [24] Torrance, E. P., “Guiding Creative Talent”, Prentice Hall, Englewood Cliffs, NJ, 1962.
- [25] Torrance, E. P., “Role of Evaluation in Creative Thinking”, Bureau of Educational research, University of Minnesota, 1964.
- [26] Tovey, M., “Thinking styles and modeling systems,” Design Studies, V 7(1), 1986.
- [27] Ullman, D., Wood, S., Craig, D., “The Importance of Drawing in the Mechanical Design Process”, Computers and Graphics, vol. 14, no. 2, 1990, pp. 263-74.
- [28] Verstijnen, I.M., Van Leeuwen, C., Goldschmidt, G., Hamel, R., and Hennessey, J. M., “Sketching and Creative Discovery”, Design Studies, Vol. 19, No. 4, 1998, pp. 519-546.

Jami J. Shah

Arizona State University, Mechanical And Aerospace Engineering Department

Tempe, Arizona 85287-6106, USA

Phone: (480) 965 6145; Fax: (480) 965 2412

E-mail: jami.shah@asu.edu

APPENDICES

This section contains a few examples of design exercises along with their associated design skills. We wish we could include more examples, but space does not permit us to do so.

Example 1:

Pure PD exercise (100% graded for PD skill)

ACTIVITY TOY SET
A new activity set for children (1 to 4 years old) is desired, to be produced from easily cleanable and durable materials. It should provide for many imaginative activities. It should be expandable for use by groups of children. It should be easily erectable and transportable. Cost should not exceed \$40 for the base set.

Example 2:

An exercise to test ideation and abstract reasoning; no pre-planning, reports required.

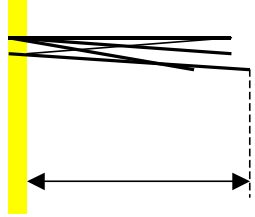
	<p><u>Spaghetti Cantilever</u> Using only the uncooked spaghetti supplied in the box and scotch tape, build the longest cantilever that can carry its own weight. You can use any of the holes in the peg board for support. The span will be measured perpendicular to the wall to the farthest point. Time limit: 30 minutes Skills evaluated: LT: 50%, AVT: 50%</p>
---	--

Example 3 (Pack Rat) & 4 (Ultra-light):

The two exercises shown on the next two pages are design contests allowing the evaluation of all skills, but the proportions are different.

Pack Rat

The Problem

Design, build, and demonstrate a device that can collect and store more golf balls than the opponent's device. Each competition will last two minutes. The playing field is 5 ft x 12 ft, surrounded by a 1 ft fence, as shown in the sketch below. Collected balls need to be stored in the respective silos. There will be one red ball (50 points), 5 yellow balls (10 pts. ea.), and 25 white balls (1 pt. ea.). You are allowed to steal balls from your opponent and to interfere with the operation of their device, without destroying it.

Skills to be evaluated: PD (10), IT (10), LT (20), VT(5), AVT(10), QVT(10), FAB(25), DM (10)

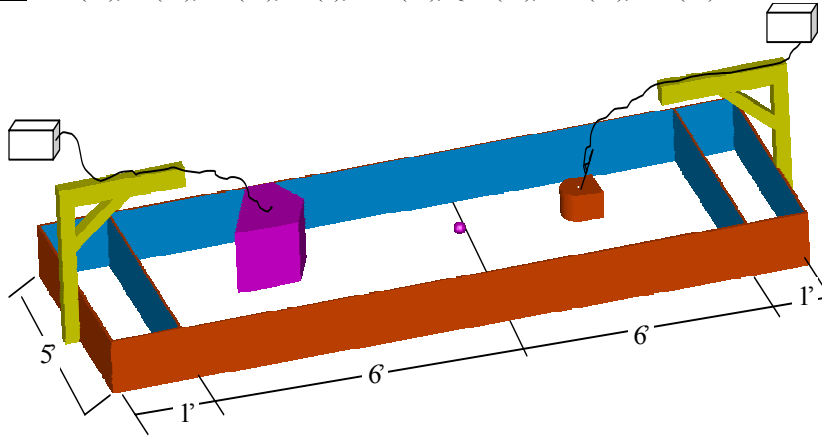
Rules

1. The device must be constructed entirely from the approved materials list.
2. The device must fit in a box 15 x 15 x 15 inches when in fully retracted position.
3. The only connection between the device and the designated operator(s) will be via electric and/or pneumatic power cords, as shown.
4. No part of the power cord can cross the center line.
5. Any balls thrown out of the playing field will be awarded to the opponent.
6. Devices that are safety hazards, or designed only for destruction will be disqualified. You cannot cut your opponent's power cord! (DISABLE and DESTROY)
7. Materials and components provided by the instructor cannot be damaged or destroyed; the group is responsible for any replacement costs. Devices carrying deliberately deformed/destroyed LEGO components will be disqualified.
8. Devices must be brought in for inspection before preliminary rounds.
9. No conceptual design changes will be allowed after the initial trials. The trials will be used to determine seeding for the tournament.
10. The same device must be used in all games.
11. To win, your device must get more points than the opponent's. Two points will be awarded for a win.
12. If neither team is winning at the two-minute mark, the play will continue on a "sudden .r death" basis for one minute, after which a tie will be declared.
13. Rewinding or altering the motors is strictly prohibited.

Instructor Provided Materials:

- 1 LEGO Tech II kit (included one 9v motor)
- 1 LEGO Pneumatic kit (includes one compressor and 2 actuators)
- 1 12v reversible DC drive motor
- 1 additional 9v motor OR additional pneumatic components (1 compressor, 1 cylinder, 1 valve)

Optional* (request & justify)

- Supplementary LEGO parts on request
- Assorted motors - you may exchange one of your motors for one in our box o' motors
- Assorted springs (small); Assorted nylon gears

Optional materials to be purchased by the group:

- Wheels - 3-inch diameter maximum
- Aluminum Sheet - any quantity
- Wood, any kind, shape or size; Rubber Bands Cardboard Foam core; Wire; Pneumatic tubing

Reports

The group report will be organized into the following parts:

Ultra Light Beam

The CHALLENGE

The challenge of this exercise is the optimal use of materials in structural design. Prove your knowledge of statics, dynamics, structural form synthesis, material behavior, failure modes, and stress analysis in designing this structure. Demonstrate how good of an engineer you are!

The PROBLEM

Design, analyze, build a structure to carry a static vertical load F located 18 in. from the support in such a way as to optimize the load to structure weight ratio.

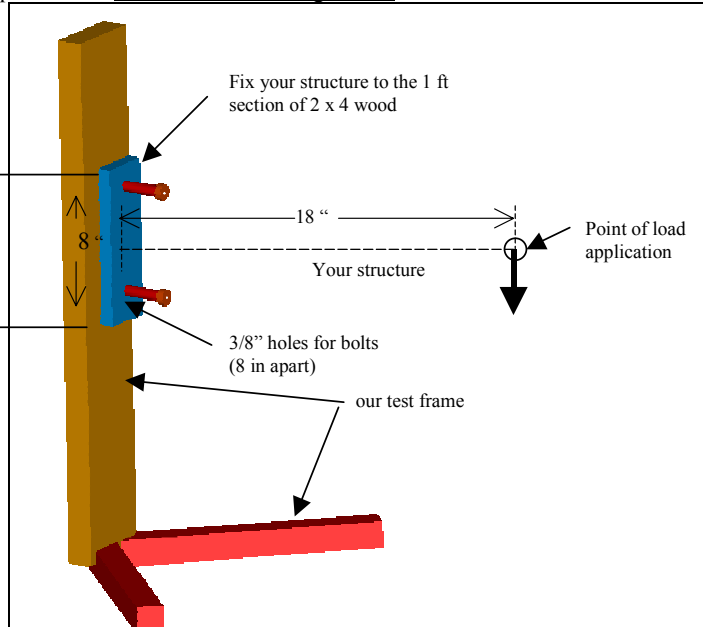

The CONSTRAINTS

- The structure must be supported only at one end, in the manner shown.
- You must provide two 3/8" holes, 10 in. vertically apart to attach the structure to the test rig.
- You can use any joining/fastening materials and methods to build the structure.
- The structure must be built only from materials shown below; the 2 x 4 wood piece is to be used only for end support.

The sheet and wire can be cut, bent, formed, joined in any way you like.

The MATERIALS

Thin steel wire 5 ft

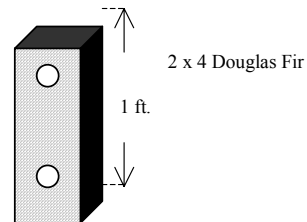
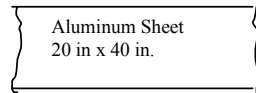
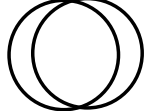

The DEADLINES

Report Part I: November 6th (Problem definition, idea generation)
 Materials distribution: November 8th
 Qualifying & Inspection: November 18-19th
 Contest & Final Report: November 20th (include Part I)

SKILLS to be Graded

PD(5), LT(10), AVT(25), QVT(30), FAB(20), DM(10)

TEST PROCEDURE

The structure will be weighed before the test (without bolts). Then it will be bolted to the test rig. A load will be applied 18 in. from the support (load center), using a saddle like arrangement or a hook (if provided). The weight will be increased until failure occurs. The max. load must be held for at least 10 seconds.

Failure Modes

- Excessive lateral deflection or twist (>0.5 in.)
- Breaking of joints
- Local or gross buckling
- Fracture or danger posed to spectators

Measure of Goodness

Maximum load carried by structure divided by the weight of the structure.